

Proportional pressure reducing valve, pilot operated

Type DRE(E) and ZDRE(E)

RE 29175

Edition: 2013-06

Replaces: 01.12

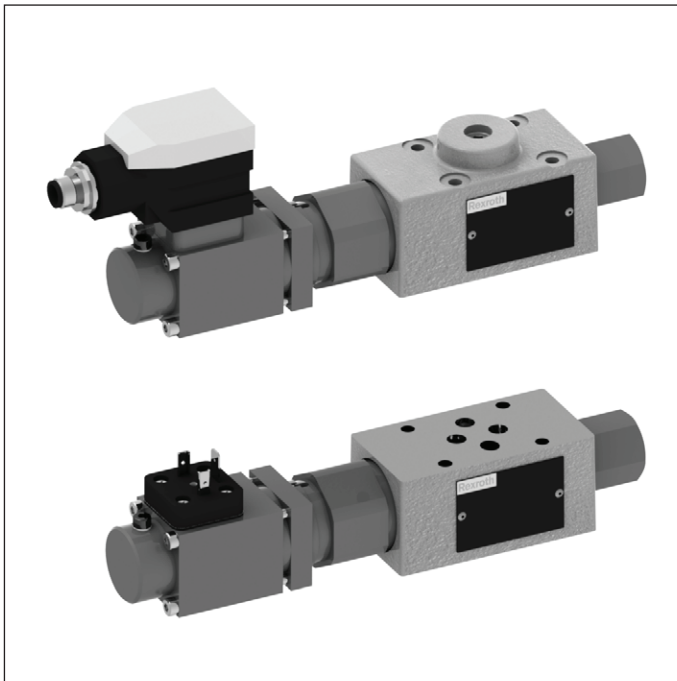

- ▶ Size 6
- ▶ Component series 1X
- ▶ Maximum operating pressure: 210 bar (DRE)
315 bar (ZDRE)
- ▶ Maximum flow: 30 l/min



Features

- ▶ Pilot operated pressure reducing valve in ports A and P1 with pressure limitation
- ▶ Operation by means of proportional solenoids
- ▶ For subplate mounting or sandwich plate design: Porting pattern according to ISO 4401-03-02-0-05
- ▶ Low manufacturing tolerance of the command value pressure characteristic curve due to electrical adjustment for the operation with external control electronics
- ▶ Minimum set pressure in ports A or P1, see page 12
- ▶ Types DREE and ZDREE with integrated electronics (OBE)
- ▶ CE conformity according to EMC Directive 2004/108/EC

Contents

Features	1
Ordering code	2, 3
Symbols	3
Function, section	4, 5
Technical data	6, 7
Electrical connection	8, 9
Characteristic curves	9 ... 13
Dimensions	14 ... 18
Accessories	18

Ordering code

01	02	03	04	05	06	07	08	09	10	11	12	13	14	15
	DRE		6			-	1X	/		M	G24			*

01	Subplate mounting Sandwich plate	no code Z
02	Proportional pressure reducing valve	DRE
03	For external control electronics With integrated electronics (OBE)	no code E
04	Size 6	6
05	Pressure reduction in channel A (subplate mounting) Pressure reduction in channel P1 (sandwich plate)	no code VP

Position of the mating connector (omitted in case of subplate mounting)

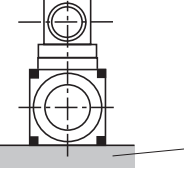
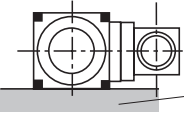
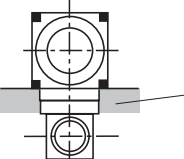
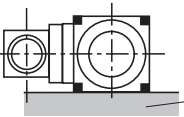
06	 <p>Valve contact surface (seal ring recesses in the housing)</p>	1
	 <p>Valve contact surface (seal ring recesses in the housing)</p>	2
	 <p>Valve contact surface (seal ring recesses in the housing)</p>	3
	 <p>Valve contact surface (seal ring recesses in the housing)</p>	4

07	Component series 10 ... 19 (10 ... 19: Unchanged installation and connection dimensions)	1X
----	--	-----------

Pressure rating

08	50 bar	50
	100 bar	100
	210 bar	210
	315 bar	315¹⁾

09	Without check valve	M
----	----------------------------	----------

Supply voltage

10	Direct voltage 24 V	G24
11	With manual override	N9
	Without manual override	no code

¹⁾ Only available for "Z" version

Ordering code

01	02	03	04	05	06	07	08	09	10	11	12	13	14	15
	DRE		6			- 1X	/	M	G24					*

Electrical connection

12	Type DRE; ZDRE:	
	Without mating connector; connector DIN EN 175301-803 Mating connector, separate order, see page 18	K4
	Type DREE; ZDREE:	
	Without mating connector; connector M12 Cable set, separate order, see page 18	K24

Interface electronics

13	Command value 0 to 10 V	A1
	Command value 4 to 20 mA	F1
	Type (Z)DRE	no code

Seal material

14	NBR seals	M
	FKM seals	V
09	Further details in the plain text	

Symbols (① = component side, ② = plate side)

Type DRE 6...

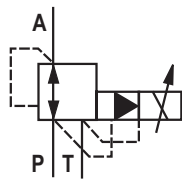

Type ZDRE 6 VP...

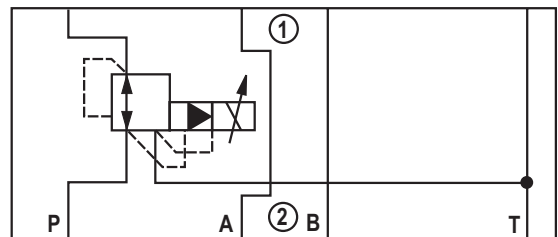

Type DREE 6...

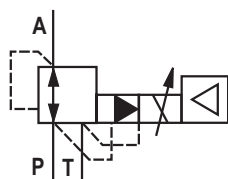

Type ZDREE 6 VP...

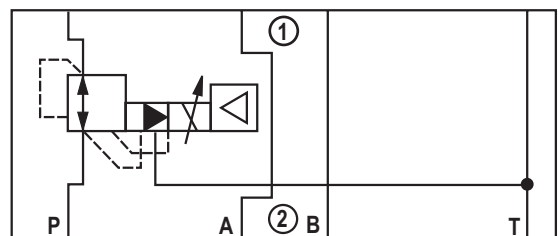

Function, section

The valve types DRE and ZDRE are electrically pilot operated 3-way pressure reducing valves with pressure limitation of the actuator.

They are used for reducing a system pressure.

Technical set-up:

The valve consists of three main assemblies:

- ▶ Pilot control valve (1)
- ▶ Proportional solenoid (2)
- ▶ Main valve (3) with main control spool (4)

Function:

Type DRE

General function:

- ▶ Command value-dependent setting of the pressure to be reduced in channel A via the proportional solenoid (2).
- ▶ In the depressurized port P, the spring (17) holds the main control spool (4) in the initial position.
- ▶ Thus, opening the connection from A to T and blocking of the connection from P to A.
- ▶ Pressure connection from port P to the ring channel (5).
- ▶ Pilot oil flows from the bore (6) to port T, via the flow controller (7), the nozzle (8) to the pilot control valve (1), the throttle gap (9) to the longitudinal groove (10) and the bores (11, 12).

Pressure reduction:

- ▶ Build-up of the pilot pressure in the control chamber (16) as function of the command value.
- ▶ Movement of the main control spool (4) to the right, hydraulic fluid flows from P to A.
- ▶ Actuator pressure pending in port A to the spring chamber (15) via channel (13) and nozzle (14).
- ▶ Increase in the pressure in port A to the set pressure of the pilot control valve (1) leads to the movement of the main control spool (4) to the left. The pressure in port A is almost equal to the pressure set at the pilot control valve (1).

Pressure limitation:

- ▶ If the pressure in port A exceeds the set pressure of the pilot control valve (1), the main control spool (4) is moved further to the left.
- ▶ Thus, opening of the connection from A to T and limitation of the pressure pending in port A to the set command value.

Type ZDRE

In principle, the function of this valve corresponds to the function of type DRE 6.

The pressure is, however, reduced in channel P1.

Type DRE 6-1X/...K4...

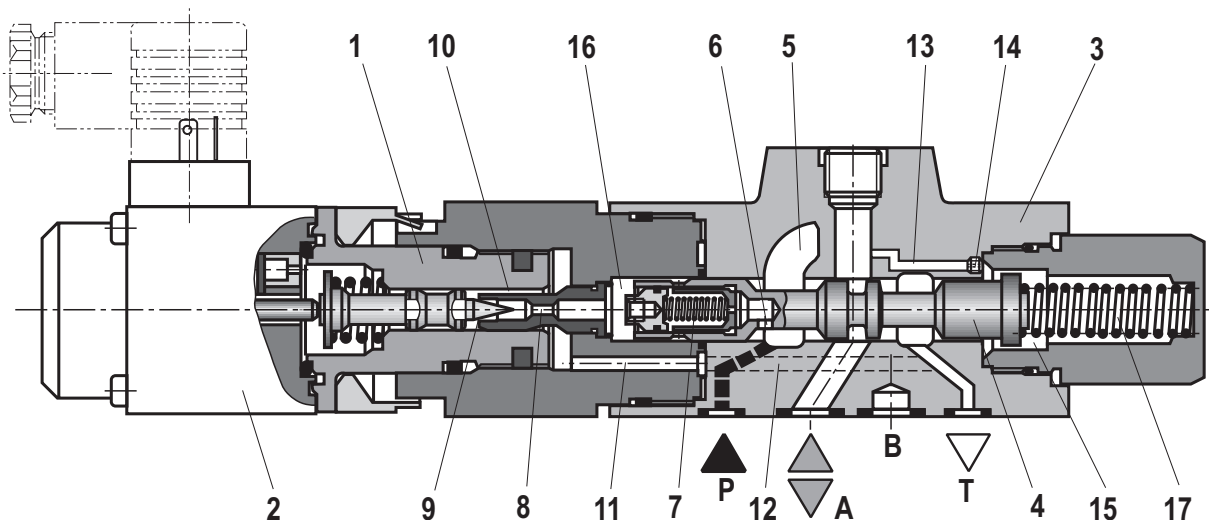

Function, section

Type (Z)DREE – with integrated electronics (OBE)

With regard to function and structure, these valves correspond to type (Z)DRE. On the proportional solenoid (2), there is moreover a housing (18) with the control electronics. Supply and command value voltage or command value current are applied to the connector (19).

In the factory, the command value pressure characteristic curve is adjusted with little manufacturing tolerance.

Type ZDREE 6 VP1-1X/...K24...

(① = component side, ② = plate side)

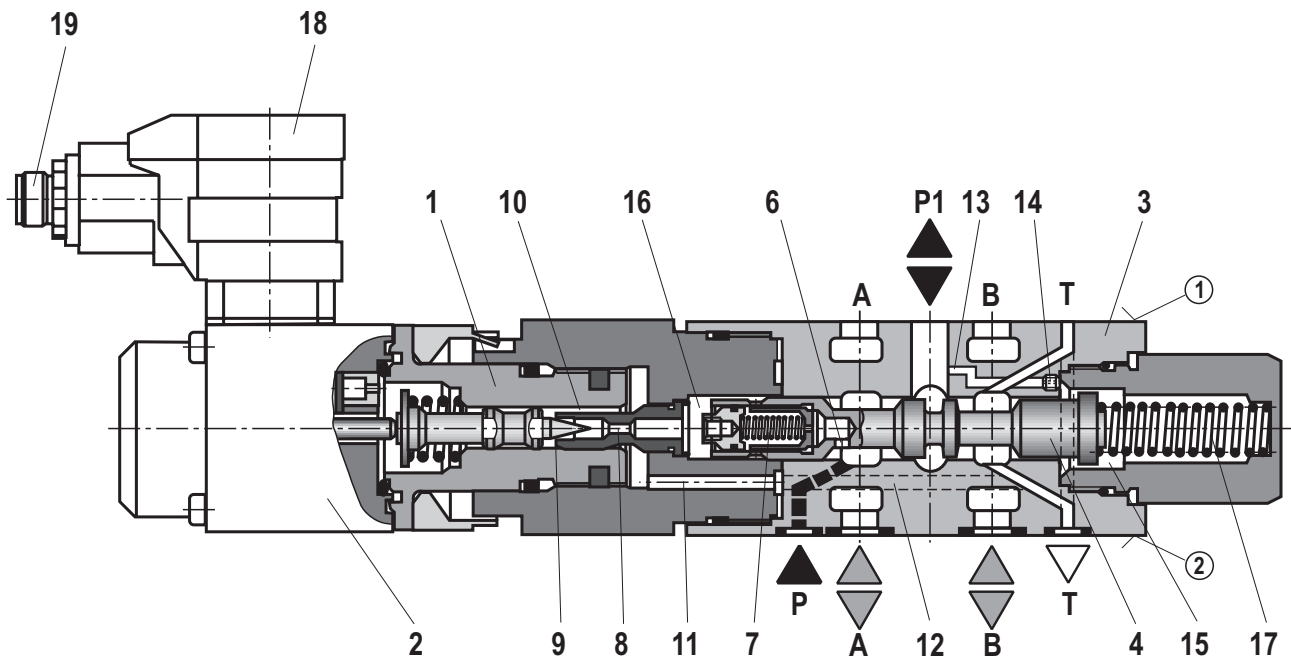

Technical data

(for applications outside these parameters, please consult us!)

general				
Weight	- Type (Z)DRE 6	kg	2.0	
	- Type (Z)DREE 6	kg	2.1	
Installation position			Any	
Storage temperature range		°C	-20 ... +80	
Ambient temperature range		°C	-20 ... +70	
hydraulic (measured with HLP46, $\vartheta_{oil} = 40 \pm 5 \text{ °C}$)				
Maximum operating pressure	- Port P or P2	bar	315	
	- Port P1, A, and B	bar	210	
	- Port T	bar	Separately and to the tank at zero pressure	
Maximum set pressure in channels P1 and A	- Pressure rating 50 bar	bar	50	
	- Pressure rating 100 bar	bar	100	
	- Pressure rating 210 bar	bar	210	
	- Pressure rating 315 bar	bar	315 ¹⁾	
Minimum set pressure with command value 0 in channels P1 and A		bar	See characteristic curves page 12	
Pilot flow		l/min	0.65	
Maximum flow		l/min	30	
Hydraulic fluid		See table page 7		
Hydraulic fluid temperature range		°C	-20 ... +80	
Viscosity range		mm ² /s	15 ... 380	
Maximum admissible degree of contamination of the hydraulic fluid cleanliness class according to ISO 4406 (c)			Class 20/18/15 ²⁾	
Hysteresis		%	±2.5 of the maximum set pressure	
Repetition accuracy		%	< ±2 of the maximum set pressure	
Linearity		%	±3.5 of the maximum set pressure	
Manufacturing tolerance of the command value pressure characteristic curve, related to the hysteresis characteristic curve, pressure increasing	- Type (Z)DRE 6	%	±2 of the maximum set pressure	
	- Type (Z)DREE 6	%	±3 of the maximum set pressure	
Step response $T_u + T_g$	10% → 90%	ms	~150	Measured with 1 liter standing hydraulic fluid column
	90% → 10%	ms	~150	

1) Only available for "Z" version.

2) The cleanliness classes specified for the components must be adhered to in hydraulic systems. Effective filtration prevents faults and at the same time increases the life cycle of the components. For the selection of the filters see www.boschrexroth.com/filter

Technical data

(for applications outside these parameters, please consult us!)

Hydraulic fluid	Classification	Suitable sealing materials	Standards
Mineral oils and related hydrocarbons	HL, HLP	NBR, FKM	DIN 51524
Environmentally compatible	– insoluble in water	HETG	ISO 15380
		HEES	
Flame-resistant	– soluble in water	HEPG	ISO 15380
	– sater-free	HFDU, HFDR	ISO 12922
	– containing water	HFC (Fuchs Hydrotherm 464 Petrofer Ultra Safe 620)	ISO 12922

**Important information on hydraulic fluids!**

- ▶ For more information and data on the use of other hydraulic fluids refer to data sheet 90220 or contact us!
- ▶ There may be limitations regarding the technical valve data (temperature, pressure range, service life, maintenance intervals, etc.)!
- ▶ The flash point of the process and operating medium used must be at least 40 K higher than the maximum solenoid surface temperature.

▶ Flame-resistant – containing water:

- Maximum operating pressure 210 bar
- Maximum hydraulic fluid temperature 60 °C
- Expected life cycle as compared to HLP hydraulic oil 30% to 100%

electrical			
Supply voltage	V	24 direct voltage	
Minimum control current	mA	100	
Maximum control current	mA	1600	
Solenoid coil resistance	– Cold value at 20 °C	Ω	5
	– Maximum hot value	Ω	7.5
Switch-on duration	%	100	
Protection class of the valve according to EN 60529	IP 65 with mating connector mounted and locked		

electrical, integrated electronics (OBE)			
Supply voltage	– Nominal voltage	VDC	24
	– Lower limit value	VDC	18
	– Upper limit value	VDC	35
Current consumption	A	≤ 1.5	
Required fuse protection	A	2.0 time-lag	
Inputs	– Voltage	V	0 to 10
	– Current	mA	4 to 20
Protection class of the valve according to EN 60529	IP 65 with mating connector mounted and locked		
Conformity	CE according to EMC Directive 2004/108/EC Tested according to EN 61000-6-2 and EN 61000-6-3		

Electrical connection (dimensions in mm)

Type (Z)DREE

Connector pin assignment	Contact	Allocation interface "A1"	Allocation interface "F1"
Supply voltage	1	24 VDC ($u(t) = 21 \text{ V to } 35 \text{ V}$); $I_{\text{max}} \leq 1.5 \text{ A}$	
Command value input	2	0 to 10 V; $R_E = 20 \text{ k}\Omega$	4 to 20 mA; $R_E = 100 \Omega$
Weight	3	0 V	
	4	Reference potential command value	

M12 plug-in connector port

Connector on amplifier

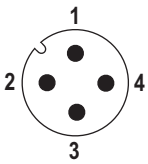

Mating connector and wire colors with pre-assembled cable set

Please order the cable set separately, see page 18

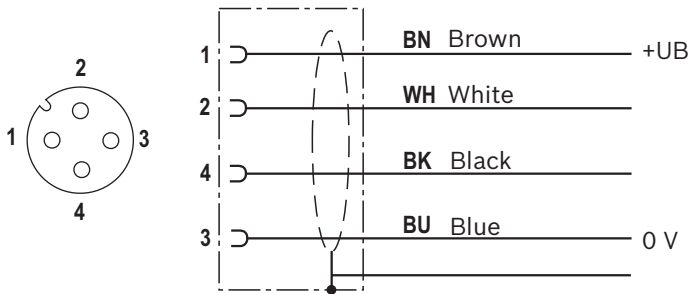

The connection for the protective earthing conductor is not provided

Connection cross-section:
4 x 0.75 mm² shielded
(connect shield in control cabinet)

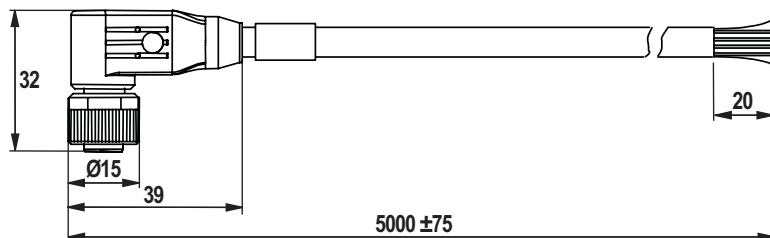
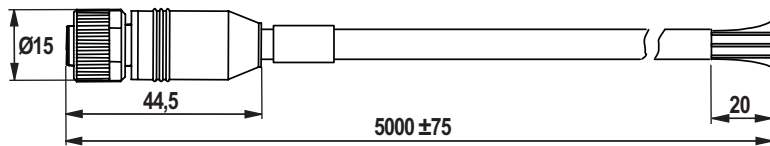

Electrical connection

Type (Z)DRE

Connection to connector

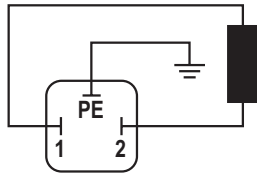

Connection to mating connector

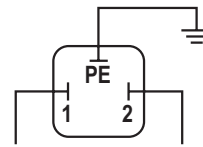

Connection cable for type (Z)DRE

- Recommendation 6-wire, 0.75 or 1 mm² plus protective earthing conductor and screening
- Only connect the screening to PE on the supply side
- Maximum admissible length = 100 m

The minimum supply voltage at the power supply unit depends on the length of the supply line (see diagram).

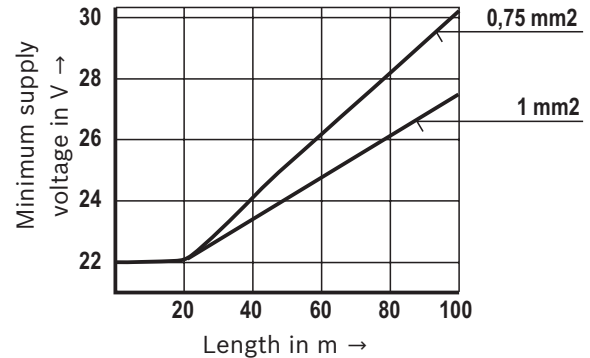

Characteristic curves (measured with HLP46, $\vartheta_{oil} = 40 \text{ °C} \pm 5 \text{ °C}$)

Pressure in port A depending on the command value (manufacturing tolerance)

without flow

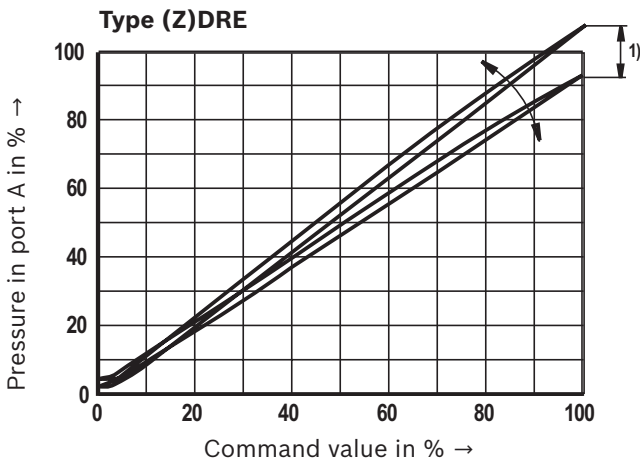

¹⁾ With type (Z)DRE, the manufacturing tolerance at the **external amplifier** (type and data sheet see page 7) can be adjusted using the command value attenuator potentiometer "**Gw**". Digital amplifiers are adjusted using the parameter "**Limit**".

The control current indicated in the technical data must not be exceeded!

In order to be able to adjust several valves to the same characteristic curve, the pressure must - with a command value of 100 % - not exceed the maximum set pressure of the relevant pressure rating at any valve.

Characteristic curves: Type (Z)DRE (measured with HLP46, $\vartheta_{oil} = 40 \text{ °C} \pm 5 \text{ °C}$)

Type (Z)DRE: Pressure in port P1 or A depending on the command value

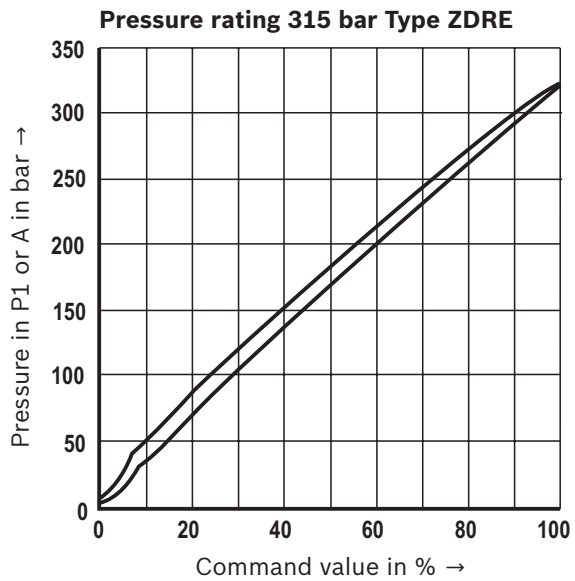
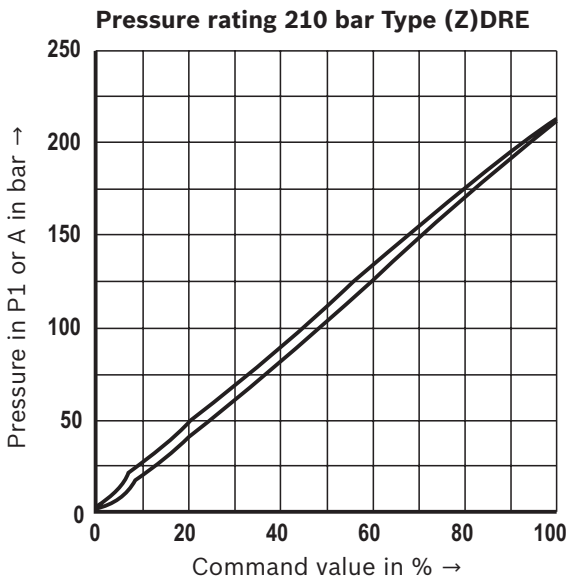
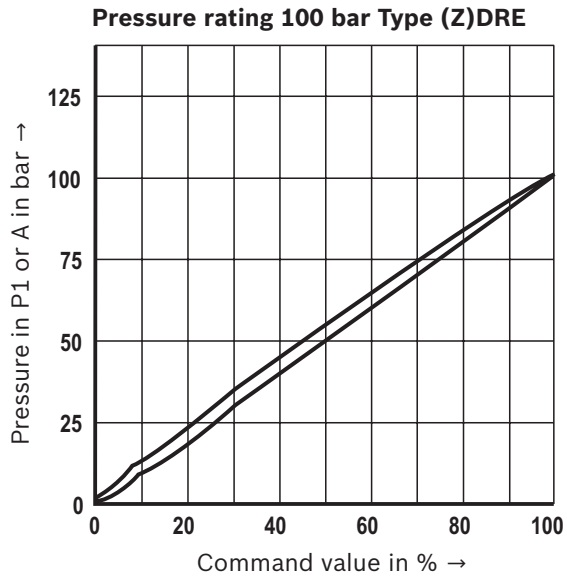
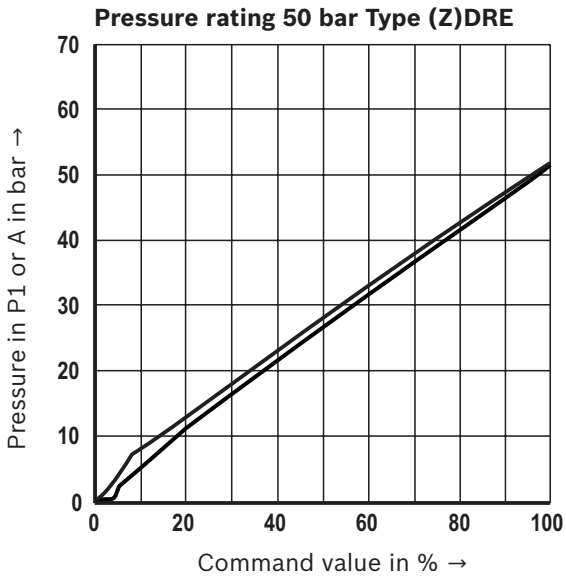

Characteristic curves: Type (Z)DREE (measured with HLP46, $\vartheta_{oil} = 40\text{ °C} \pm 5\text{ °C}$)

Type (Z)DRE(E): Pressure in port P1 or A depending on the command value

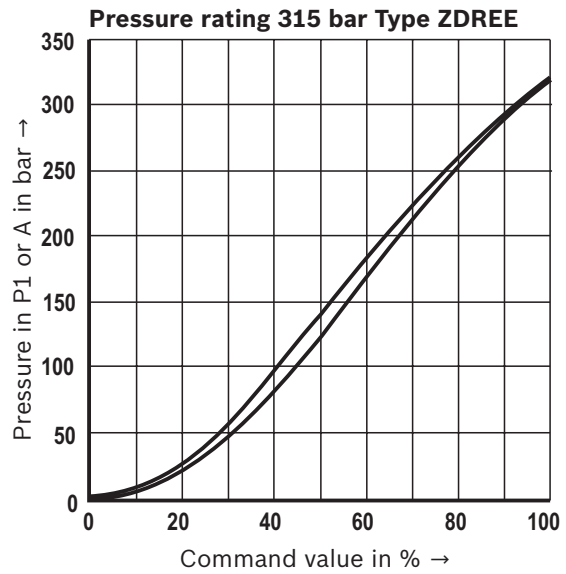
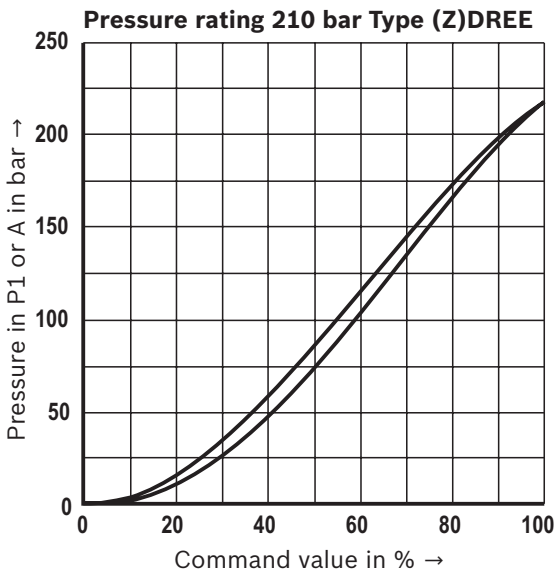
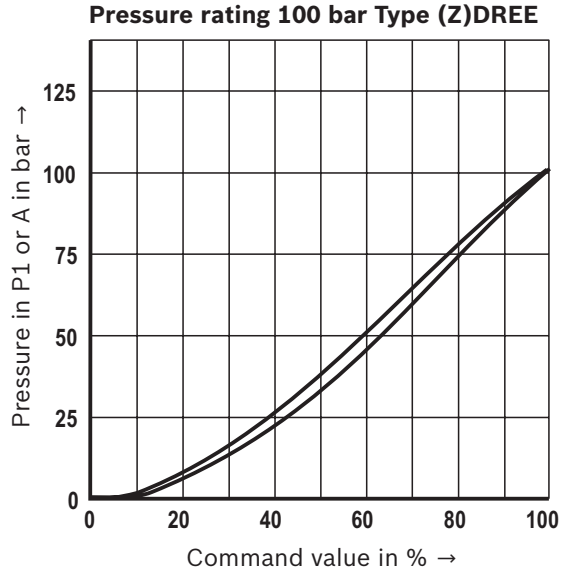
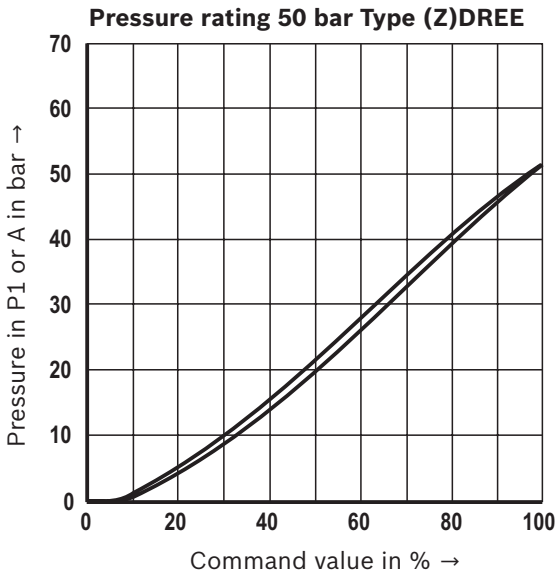

Characteristic curves (measured with HLP46, $\vartheta_{oil} = 40 \text{ °C} \pm 5 \text{ °C}$)

Minimum set pressure in port P1 or A with command value 0 V (without counter pressure in channel T)

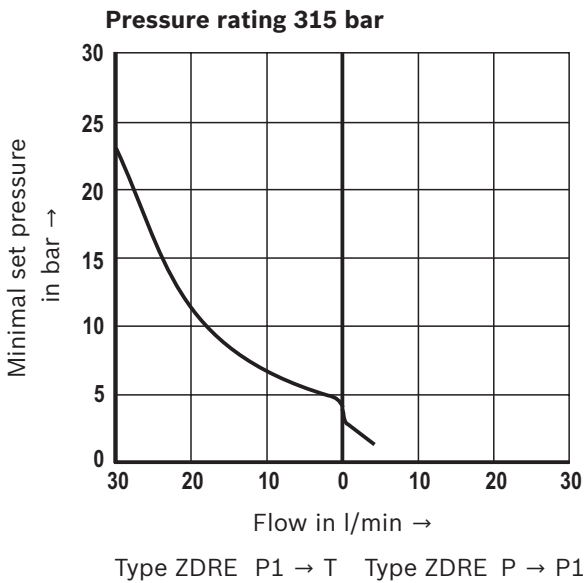
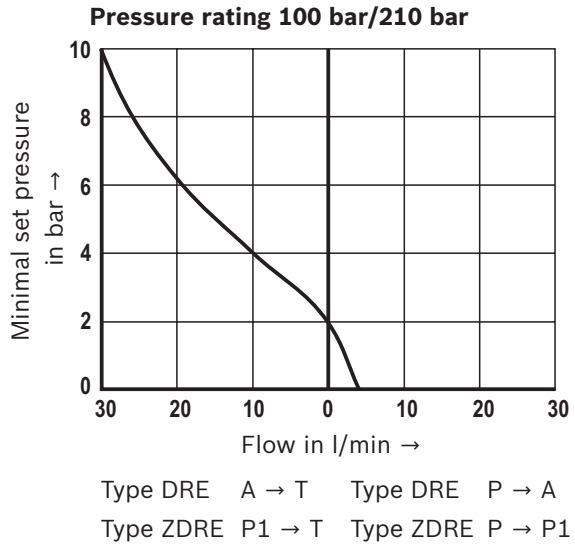
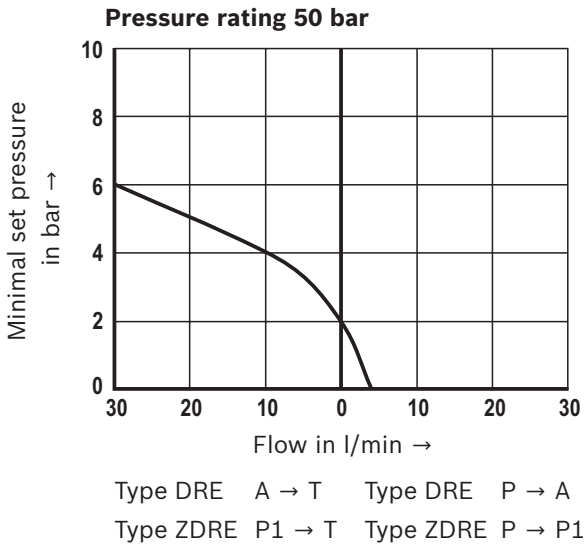

Characteristic curves (measured with HLP46, $\vartheta_{oil} = 40 \text{ }^\circ\text{C} \pm 5 \text{ }^\circ\text{C}$)

Pressure in channel P1 or A – flow

Pressure rating 50 bar

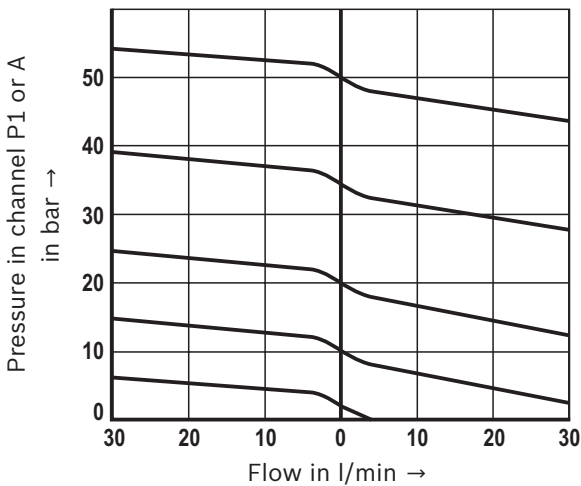

Type DRE A → T Type DRE P → A
Type ZDRE P1 → T Type ZDRE P → P1

Pressure rating 100 bar

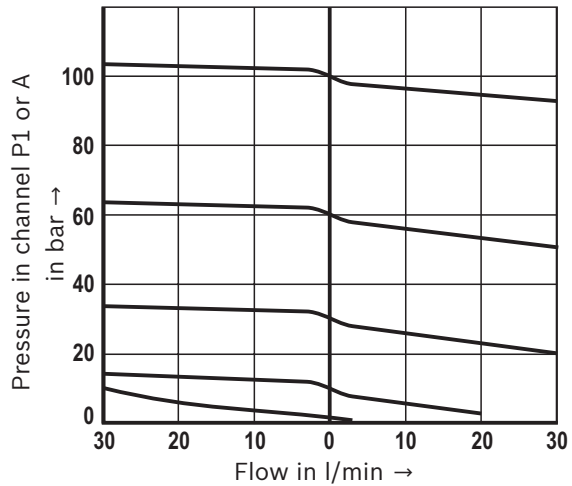

Type DRE A → T Type DRE P → A
Type ZDRE P1 → T Type ZDRE P → P1

Pressure rating 210 bar

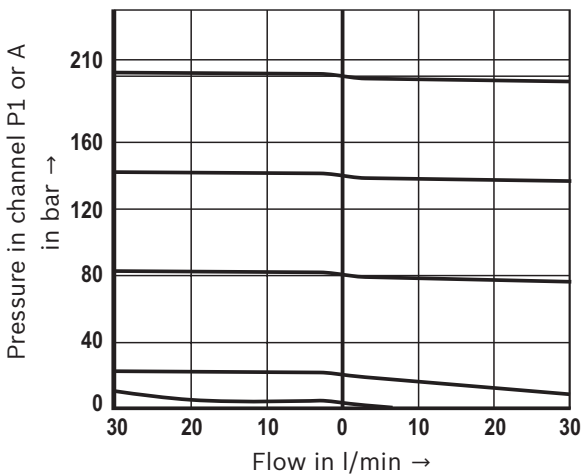

Type DRE A → T Type DRE P → A
Type ZDRE P1 → T Type ZDRE P → P1

Pressure rating 315 bar

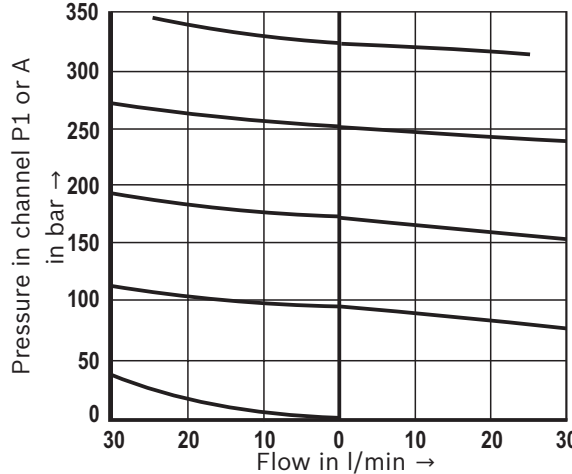

Type ZDRE P1 → T Type ZDRE P → P1

Δp - q_v characteristic curves

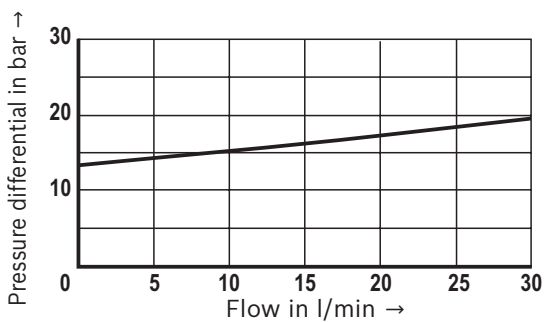

Type DRE(E) P → A
Type ZDRE(E) P2 → P1

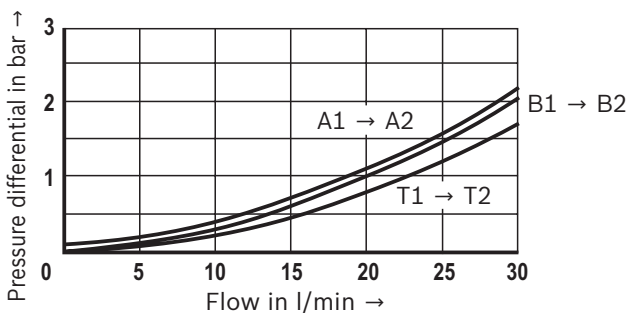

Notice!

The shown Δp value corresponds to the minimum pressure available in port P (P2) minus the maximum pressure to be controlled in port A (P1).

Dimensions: Type DRE
(dimensions in mm)

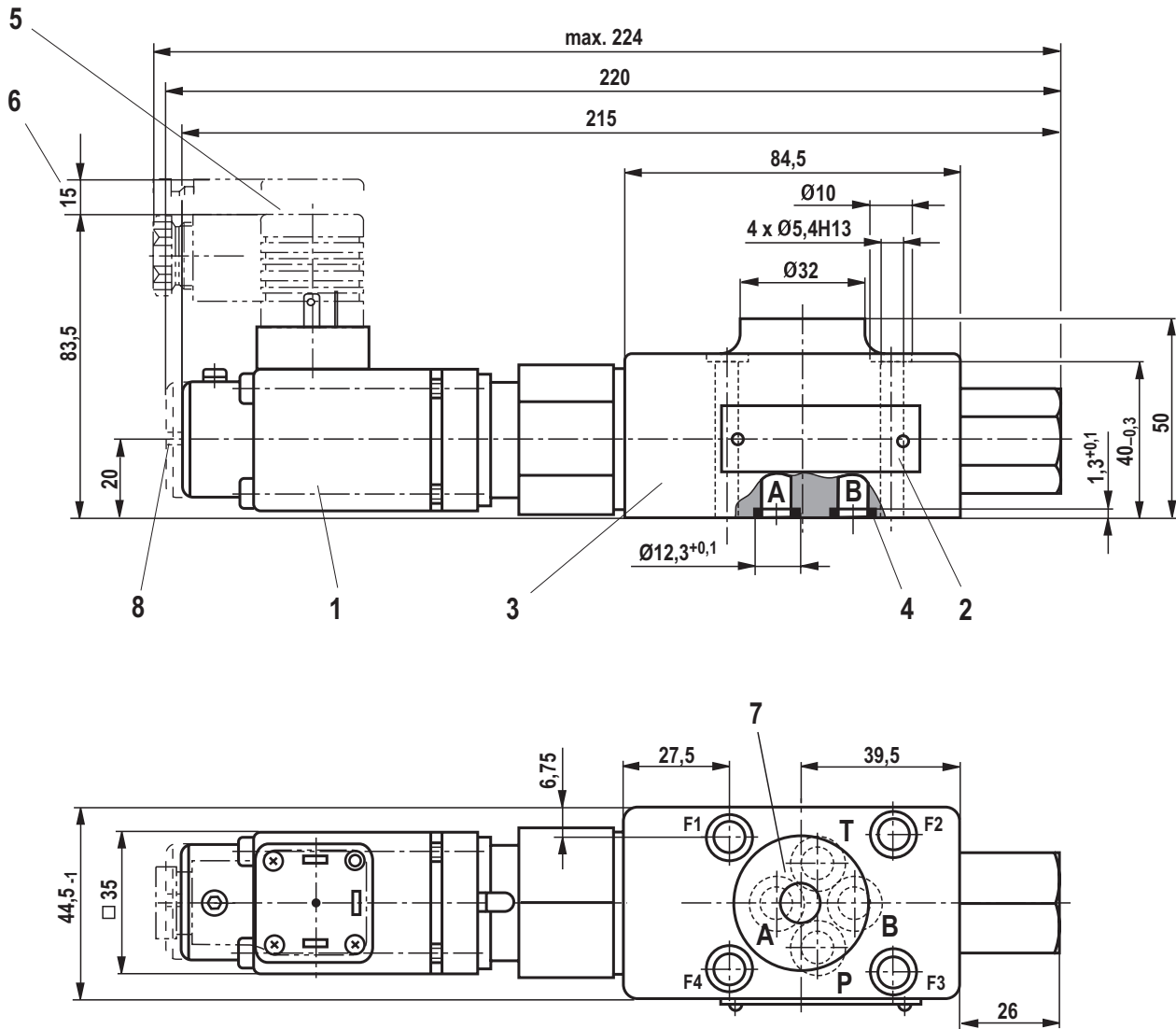

- 1 Proportional solenoid **without** manual override
- 2 Name plate
- 3 Valve housing
- 4 Identical seal rings for ports A, B, P and T
- 5 Mating connector, separate order, see page 18
- 6 Space required for removing the mating connector
- 7 Porting pattern according to ISO 4401-03-02-0-05
- 8 Proportional solenoid **with** manual override

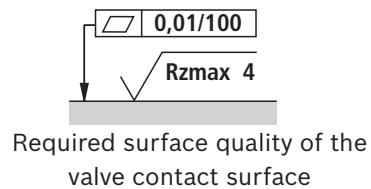

Notice!

The dimensions are nominal dimensions which are subject to tolerances.

Valve mounting screws and **subplates** see page 18.

Dimensions: Type DREE
(dimensions in mm)

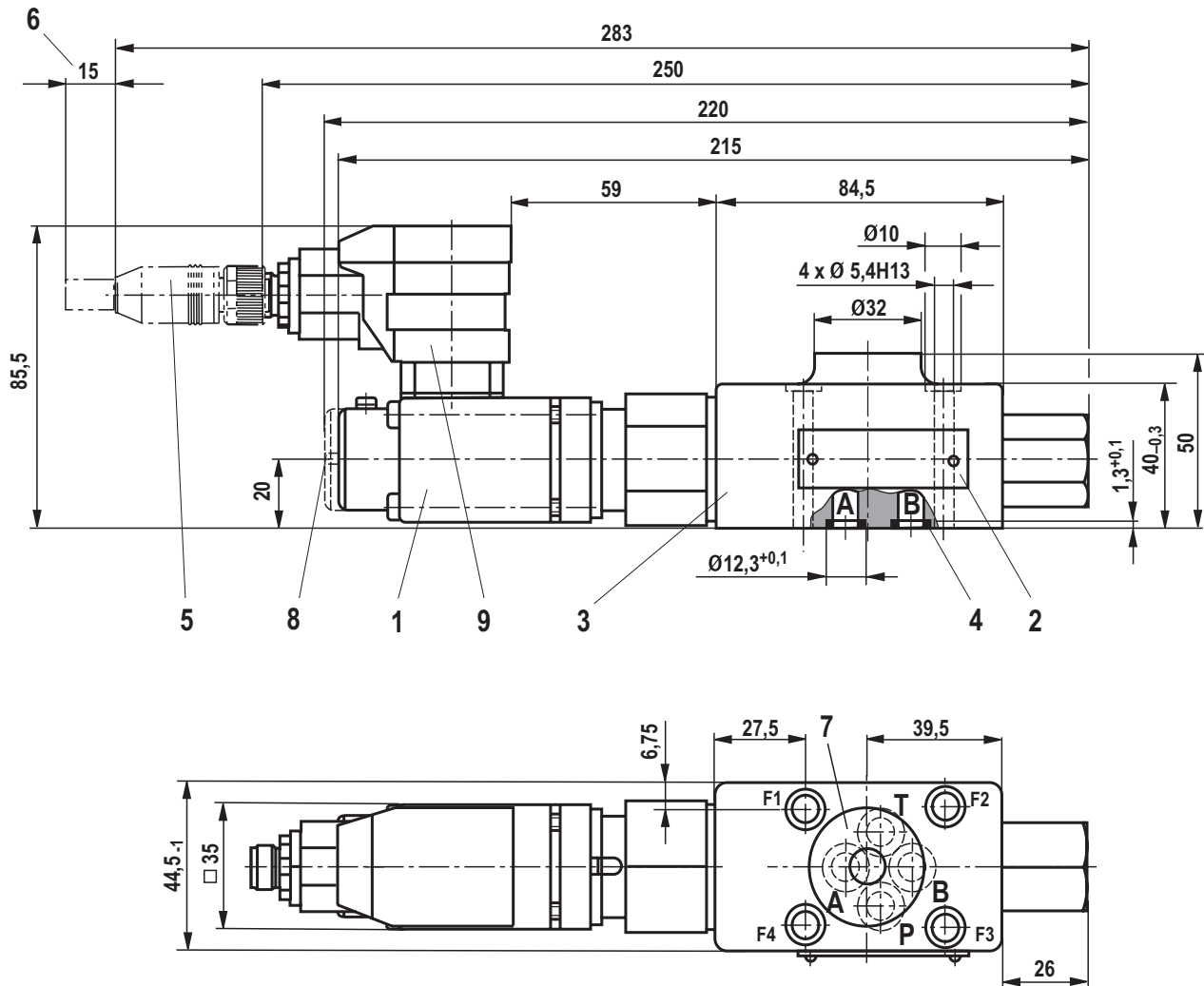

- 1 Proportional solenoid **without** manual override
- 2 Name plate
- 3 Valve housing
- 4 Identical seal rings for ports A, B, P and T
- 5 Mating connector, separate order, see page 18
- 6 Space required for removing the mating connector
- 7 Porting pattern according to ISO 4401-03-02-0-05
- 8 Proportional solenoid **with** manual override
- 9 Integrated electronics (OBE)

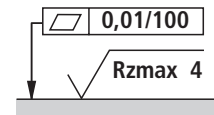

Required surface quality of the valve contact surface

Notice!

The dimensions are nominal dimensions which are subject to tolerances.

Valve mounting screws and **subplates** see page 18.

Dimensions: Type ZDRE
(dimensions in mm)

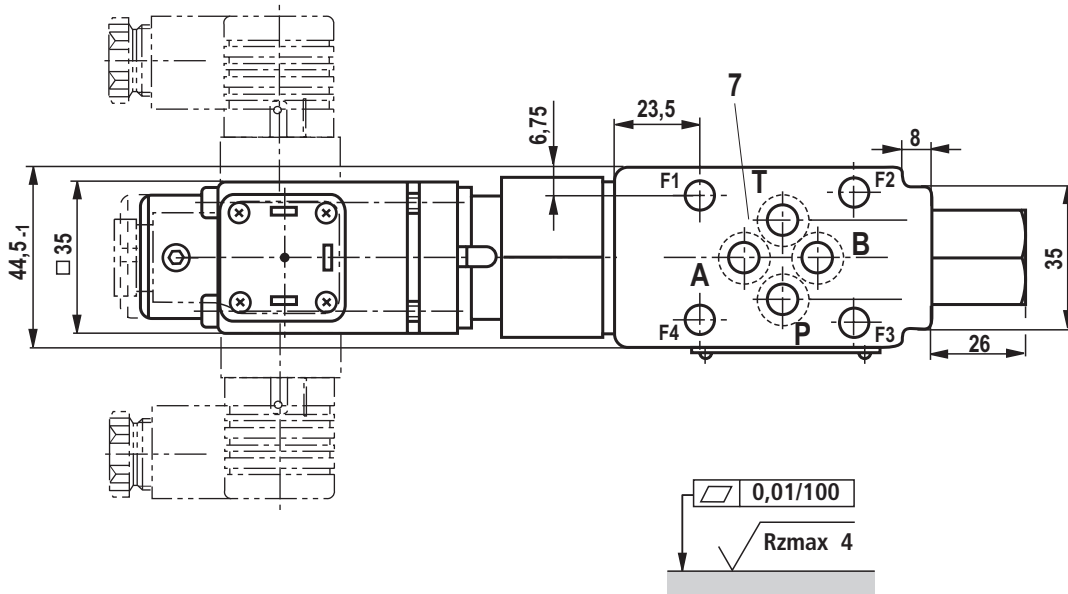
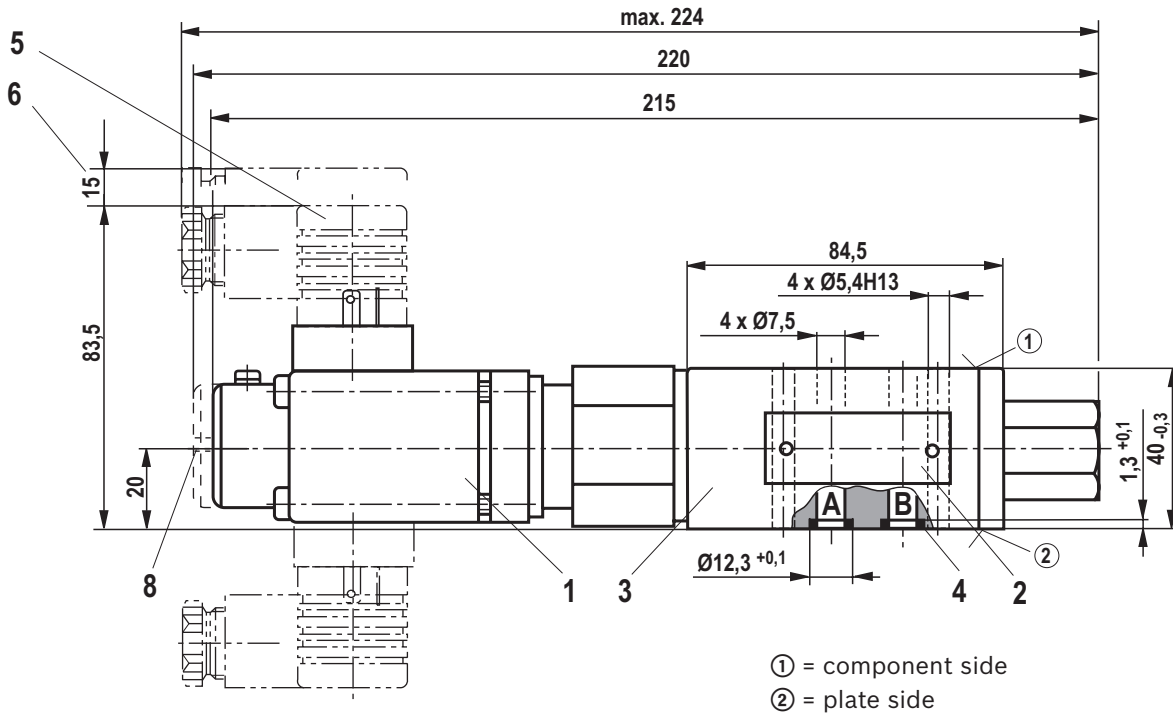

Required surface quality of the valve contact surface

Notice!

The dimensions are nominal dimensions which are subject to tolerances.

Item explanations see type DRE on page 14, **valve mounting screws** and **subplates** see page 18.

Dimensions: Type ZDREE
(dimensions in mm)

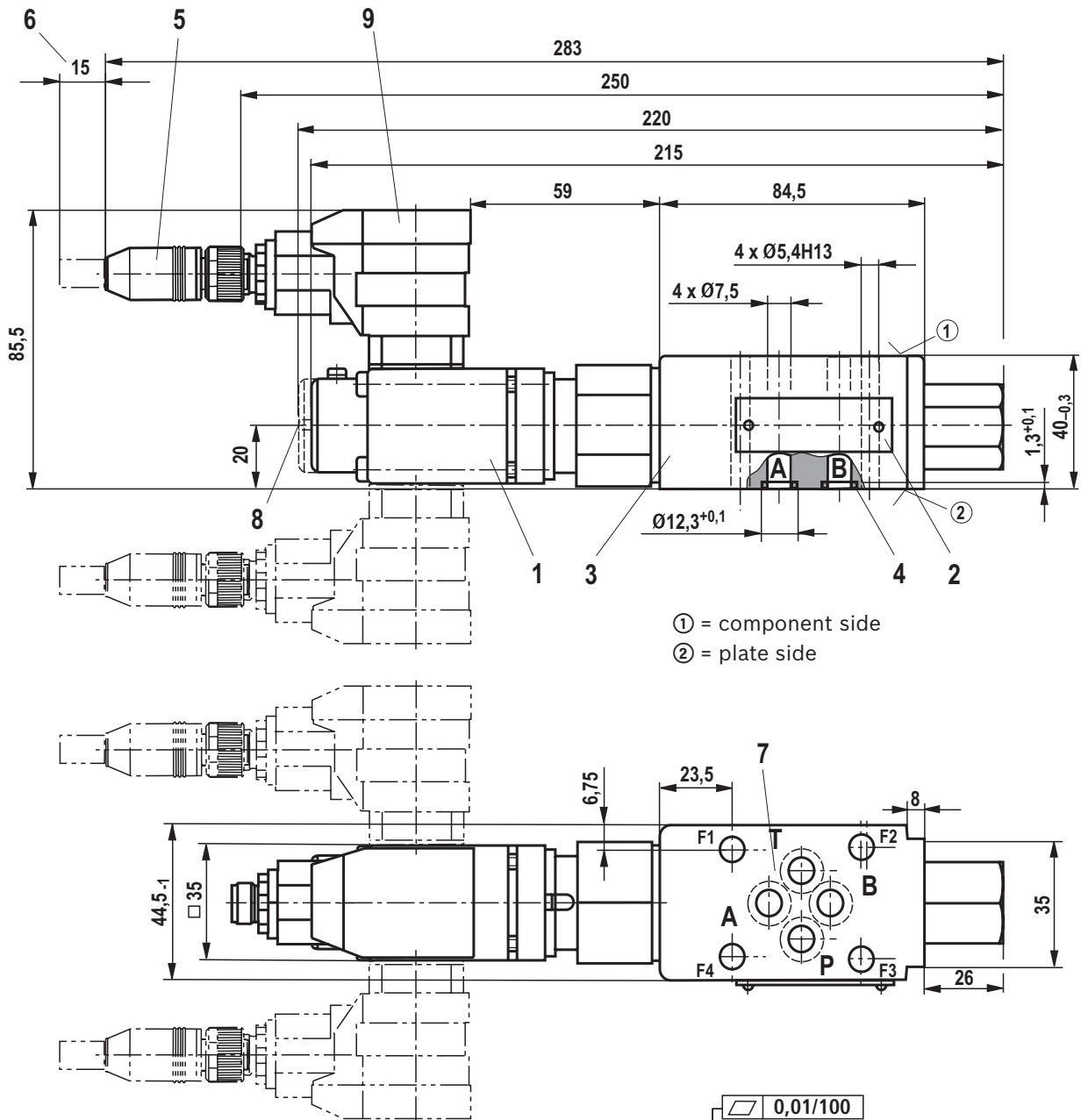

① = component side
② = plate side

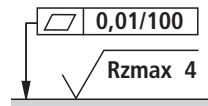

Required surface quality of the valve contact surface

Notice!

The dimensions are nominal dimensions which are subject to tolerances.

Item explanations see type DREE on page 15, **valve mounting screws** and **subplates** see page 18.

Dimensions

Hexagon socket head cap screws		Material number
Type DRE(E)	4x ISO 4762 - M5 x 50 - 10.9-fIZn-240h-L (friction coefficient $\mu_{\text{total}} = 0.09$ to 0.14) tightening torque $M_A = 7 \text{ Nm} \pm 10\%$	
Type ZDRE(E)	4x ISO 4762 - M5 - 10.9-fIZn-240h-L (friction coefficient $\mu_{\text{total}} = 0.09$ to 0.14) tightening torque $M_A = 7 \text{ Nm} \pm 10\%$	

Notice: The tightening torque of the hexagon socket head cap screws refers to the maximum operating pressure!

Subplates	Data sheet
Size 6	45052

Accessories (not included in the scope of delivery)

Proportional amplifier for type (Z)DRE	Data sheet	Material number
VT-MSPA1-10 in modular design	30223	R901142355
VT-VSPD-1 in Euro-card format	30523	R901077287
VT-VSPA1-10 in Euro-card format	30100	R901152628

Mating connector for type (Z)DRE	Data sheet	Material number
Mating connector (black) DIN EN 175301-803	08006	R901017011

Cable sets for type (Z)DREE		Material number
Cable set VT-SSPA1-1X/M12/1/V00	Assembled cable with straight mating connector	R901241656
Cable set VT-SSPA1-1X/M12/2/V00	Assembled cable with angular mating connector	R901241651

Bosch Rexroth AG
Hydraulics
Zum Eisengießer 1
97816 Lohr am Main, Germany
Phone +49 (0) 93 52/ 18-0
documentation@boschrexroth.de
www.boschrexroth.de

© This document, as well as the data, specifications and other information set forth in it, are the exclusive property of Bosch Rexroth AG. It may not be reproduced or given to third parties without its consent.
The data specified above only serve to describe the product. No statements concerning a certain condition or suitability for a certain application can be derived from our information. The information given does not release the user from the obligation of own judgment and verification.
It must be remembered that our products are subject to a natural process of wear and aging.

Bosch Rexroth AG
Hydraulics
Zum Eisengießer 1
97816 Lohr am Main, Germany
Phone +49 (0) 93 52/18-0
documentation@boschrexroth.de
www.boschrexroth.de

© This document, as well as the data, specifications and other information set forth in it, are the exclusive property of Bosch Rexroth AG. It may not be reproduced or given to third parties without its consent.
The data specified above only serve to describe the product. No statements concerning a certain condition or suitability for a certain application can be derived from our information. The information given does not release the user from the obligation of own judgment and verification.
It must be remembered that our products are subject to a natural process of wear and aging.

